

THK CO., LTD.
INVESTOR INFORMATION FY2026-1Q

May 11, 2026

Our company decided and announced on February 2, 2026, to transfer the transportation equipment business.
当社は、2026年2月2日に輸送機器事業を譲渡することを決定・発表しました。

Major Financial Data 主要財務指標	2-3	Major Financial Data 主要財務指標
Management Strategy 経営戦略	4	System of Management Strategy 経営戦略の体系
	5	PMVV (Purpose, Mission, Vision, Value) PMVV(経営理念、ミッション、ビジョン、バリュー)
	6	Full-Scale Globalization グローバル展開
	7	Industrial Machinery 産業機器
Numerical Targets 数値目標	8	Numerical Targets 数値目標
	9	Capital Expenditure and Number of Employees 設備投資額と従業員数
Current Business Situation 足元の状況	10	Orders Received by Region<Industrial Machinery Business> 地域別受注状況(産業機器事業)
	11	User Sales Breakdown by Industry 業種別売上高構成比
	12	Trend in Japan Orders, Sales, Backlog <Parent Basis> 受注高・売上高・受注残高の推移-単独-
	13	Trend in Orders Classified by Industry <Parent Basis> 業種別受注高の推移-単独-
Financial Statements 財務諸表	14-15	Consolidated Statements of Income 連結損益計算書
	16	Consolidated Balance Sheets 連結貸借対照表
	17	Segment Information セグメント情報
	18	Overviews of Major Subsidiaries 主要子会社
	19	Capital Expenditure, Depreciation 設備投資額、減価償却費
	19	R&D Expenses, Number of Employees 研究開発費、従業員数
	20-21	Non-Consolidated Statement of Income 単独損益計算書
Company Profile 会社概要	22-23	Subsidiaries and Affiliate 連結子会社および持分法適用関連会社
	24	Main Products and Service 主要製品・サービス
	25	History 沿革
	26	Plants in Japan 日本の生産拠点
	27	Plants in Asia アジアの生産拠点
	28	Plants in the Americas and Europe 欧米の生産拠点
	29-30	Common Stock Information 株式情報
	31	Corporate Data 会社データ

Revenue 売上収益

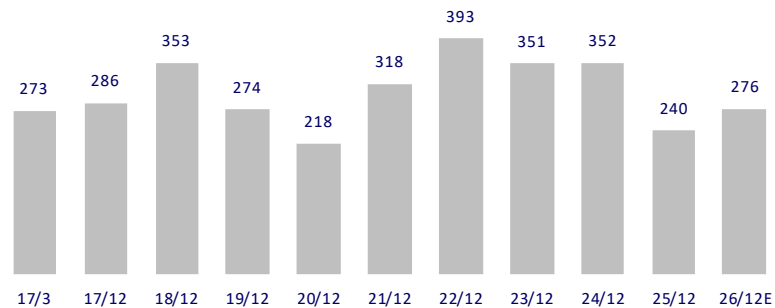

Operating Income, Margin 営業利益、営業利益率

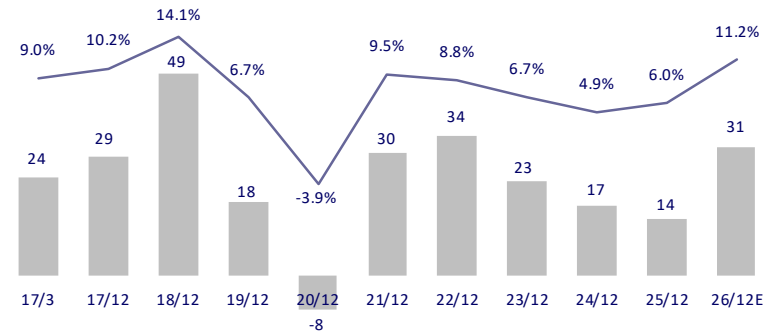

Earnings Per Share 一株当たり当期利益

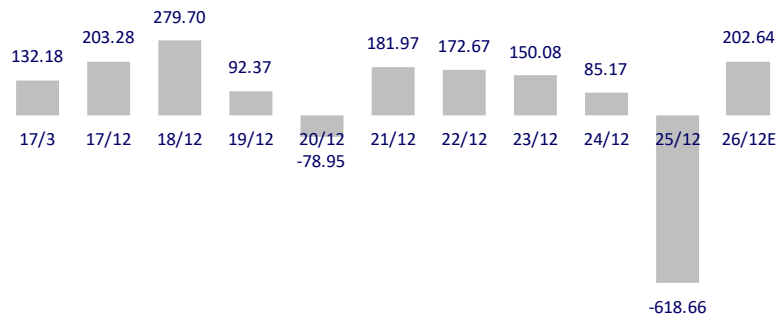

Dividend per Share, Payout Ratio (Consolidated Basis)
一株当たり年間配当金、配当性向 (連結ベース)

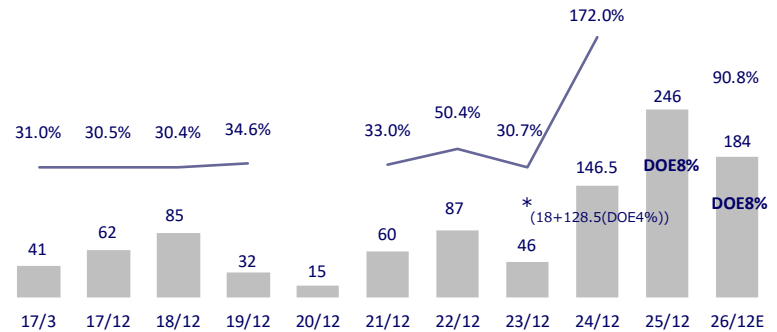

Due to the transfer of the Automotive & Transportation business, the revenue and operating profit in the actual results for the fiscal year ending December 2025 and the forecast for the fiscal year ending December 2026 do not include this business.

輸送機器事業の譲渡に伴い、2025年12月期実績及び2026年12月期の業績予想の売上収益及び営業利益には同事業は含まれておりません。

The financial results for the fiscal year ending in December 2017 is based on an irregular accounting period: 9 months for Japanese companies and 12 months for overseas companies.

2017年12月期業績は、日本9ヵ月、海外12ヵ月の変則決算期をベースとしております。

*Since the new dividend policy became effective as of the third quarter period of fiscal year 2024, the year-end dividend for the fiscal year ending December 31, 2024, was calculated based on a DOE of 4%, which is for the half of the fiscal year.

2024年12月期 第3四半期より新たな配当方針が適用されたため、2024年12月期の期末配当については半期分となるDOE4%を基準に算出。

Rate of Return on Equity 株主資本当期利益率



Rate of Return on Assets 総資産事業利益率



Inventory, Inventory Turnover Period (Months) 棚卸資産、回転月数

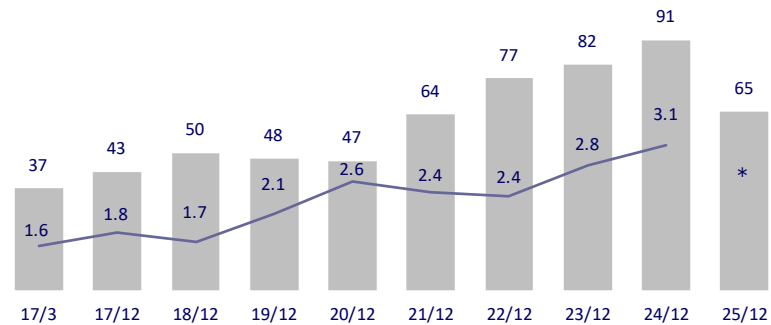

Total Assets, Turnover Ratio 総資産、総資産回転率

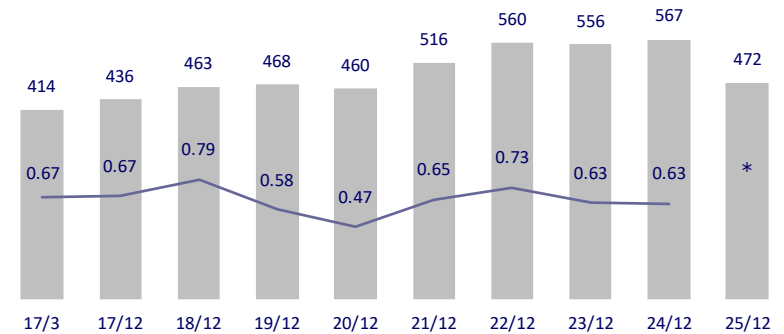

*Due to the transfer of the Automotive & Transportation business, the actual figures for rate of return on assets, inventory turnover period, and total asset turnover ratio for the fiscal year ending December 2025 are not provided.

輸送機器事業の譲渡に伴い、総資産事業利益率、棚卸資産回転月数及び総資産回転率の2025年12月期実績は記載しておりません。

The financial results for the fiscal year ending in December 2017 is based on an irregular accounting period: 9 months for Japanese companies and 12 months for overseas companies. 2017年12月期業績は、日本9ヵ月、海外12ヵ月の変則決算期をベースとしております。

System of Management Strategy 経営戦略の体系

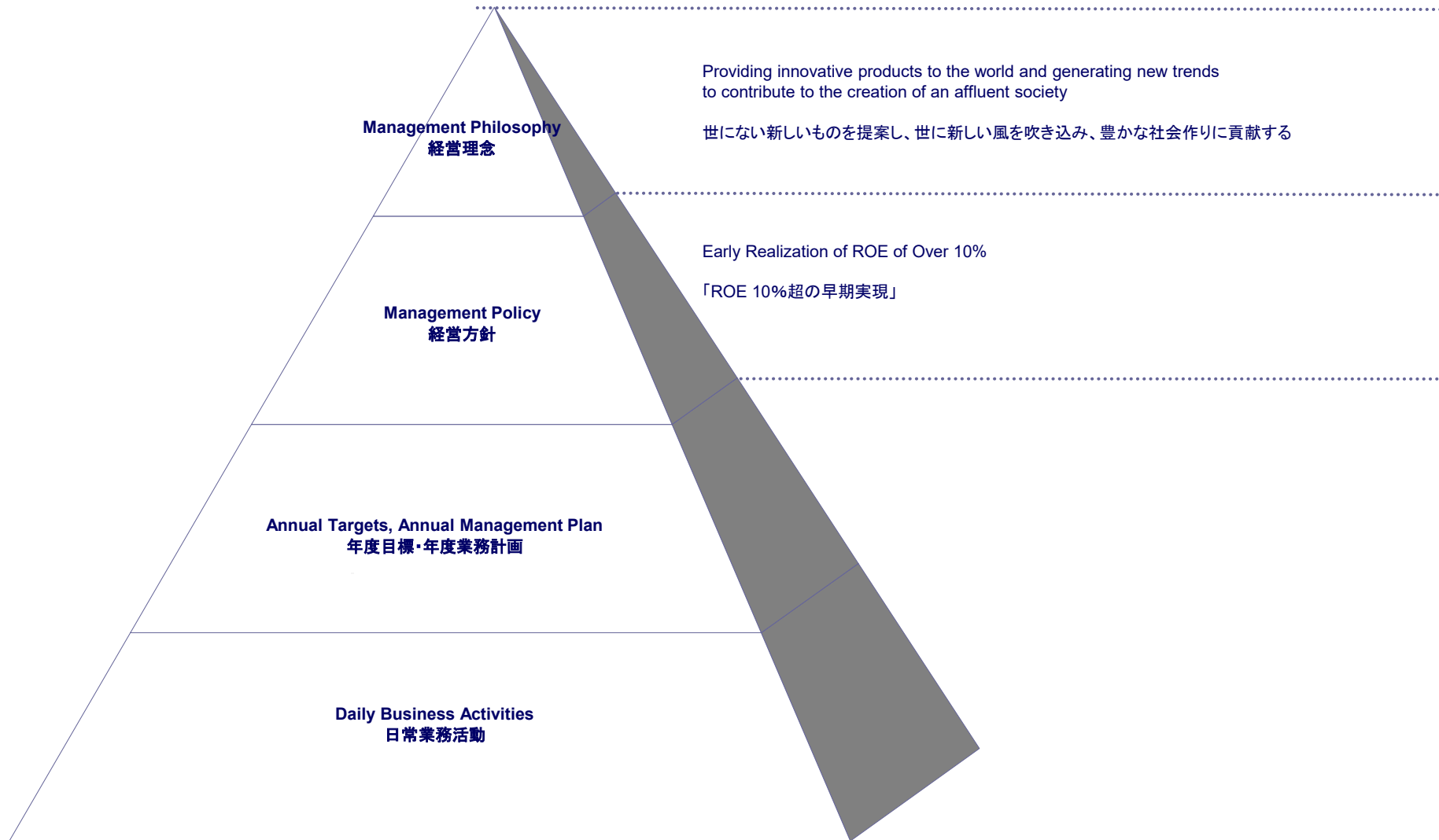

PMVV (Purpose, Mission, Vision, Value)
PMVV (経営理念、ミッション、ビジョン、バリュー)



Value
バリュー



挑戦
Courage

変化をおそれず、
自ら一步を踏み出し、
成長し続けます

Continue to grow by taking the
initiative and embracing change.



対話
Communication

互いを理解し、
アイデアを出し合うことで、
新たな価値を生み出します

Generate new value
through mutual understanding
and collaboration.



誠実
Integrity

現場で事実を見極め、
真摯に向き合い、信頼に応えます

※現場=自分たちが関わり価値が生み出されるあらゆる場

Honor the trust placed in us by engaging
honestly with the facts in the *gemba*.
Gemba = Anywhere in our work where we create value

※1 当社は、機械の直線運動部における「ころがり化」技術を基盤に、メカトロニクス製品とIoTなどのデジタル技術を活用した「つながる」技術を組み合わせたソリューションを提供しています。
「製造業は現場で付加価値が創られる」という考えのもと、世界中のお客様の課題解決に貢献するとともに、持続可能な社会の実現を目指しています。
「メカトロエッジ」とは、THKが提供する、メカニカルコンポーネント(機械要素部品)、メカトロニクス、IoT・エッジコンピューティングサービスの総称です。

※2 製品提供に加え、AIやIoTなどのデジタル技術を活用した付加価値の高いサービスも提供することで、製造業の枠を超え、お客様に新たな価値を提供することを目指しています。

¹ "Monozukuri" is a philosophy of manufacturing, craftsmanship, and innovation.

² Our company has a foundation in technologies that enable the linear motion of machines through rolling motion, and we provide solutions that combine mechatronics products with IoT and other digital connection technologies.

Based on the idea that "added value in the manufacturing industry is created in the *gemba*," we help customers around the world solve problems and work toward the realization of a sustainable society.

"Mechatroedge" is a term that combines mechanical components, mechatronics, and IoT/edge computing services provided by THK.

³ In addition to supplying products, we aim to go beyond the boundaries of the manufacturing industry and offer new value to our customers by providing high-value-added services that utilize digital technologies such as AI and IoT.

Full-Scale Globalization グローバル展開

Building a Tetra-lateral Operational Network: Japan, the Americas, Europe and Asia
四極での営業網の構築：日本、米州、欧州、アジア

Promotion of Regional Production Optimization
最適地生産の推進

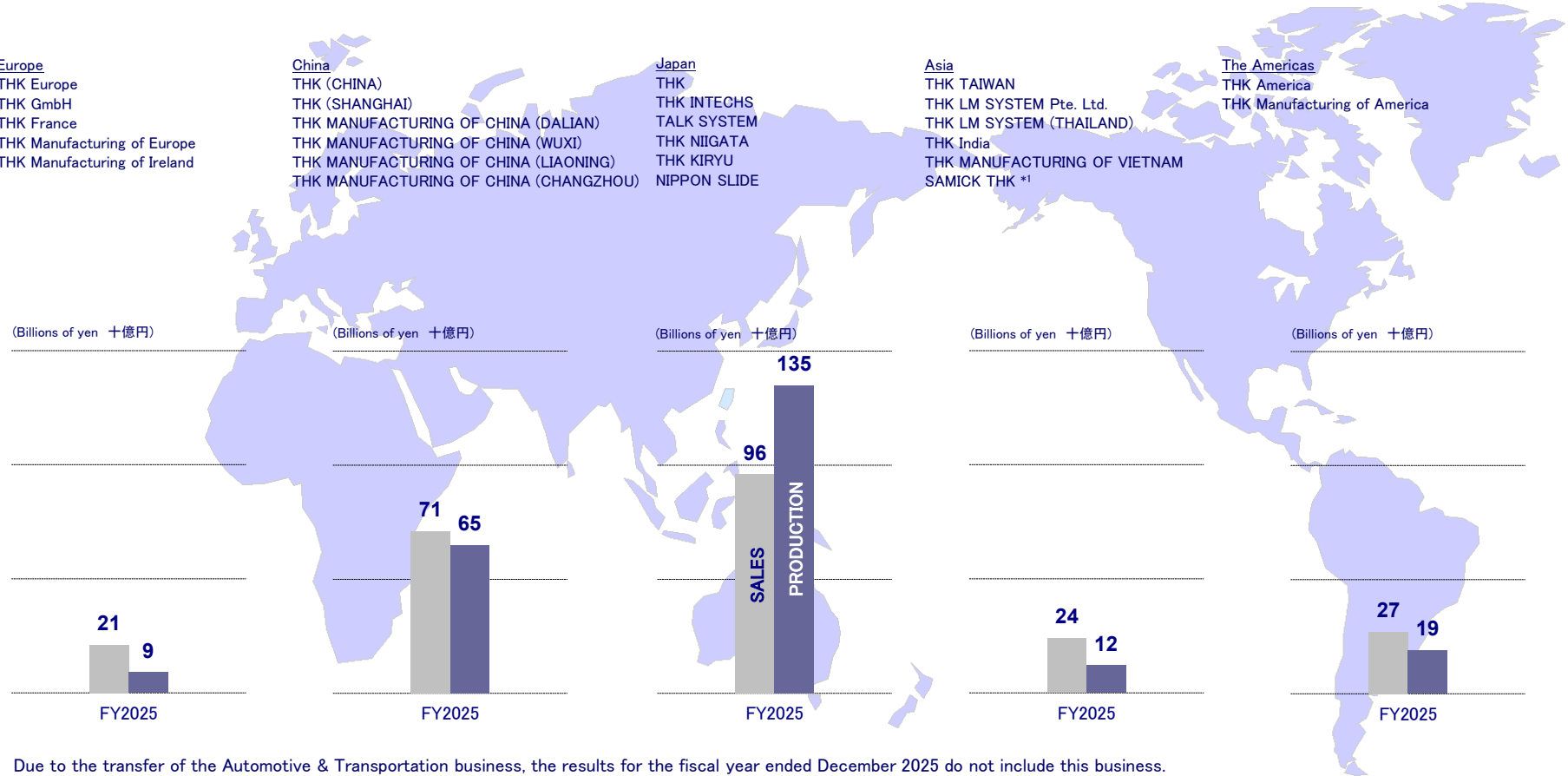

Due to the transfer of the Automotive & Transportation business, the results for the fiscal year ended December 2025 do not include this business.
輸送機器事業の譲渡に伴い、2025年12月期実績には同事業は含まれておりません。

*1 An equity investee
持分法適用関連会社

Industrial Machinery
産業機器

Expansion from Capital Goods into Consumer Goods
資本財から消費財(民生分野)への展開を図る

Capital Goods
資本財

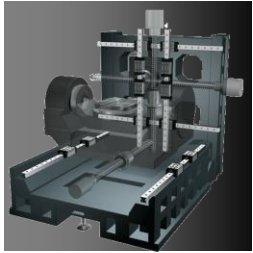

Machine tools
工作機械

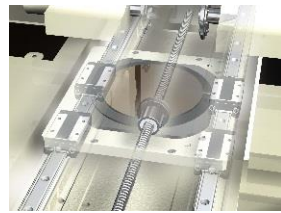

Semiconductor Production
Equipment
半導体製造装置



Industrial robots
産業用ロボット



New Businesses
新規分野

Medical Equipment
医療機器



Aircraft
航空機



Linear Motion
Core Technology
直動コア技術

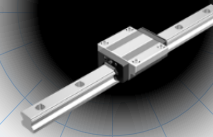

3D Printer
3Dプリンター



Seismic Isolation System
免震装置



Renewable Energy
再生可能エネルギー



Numerical Targets
数値目標

Billions of yen
 十億円

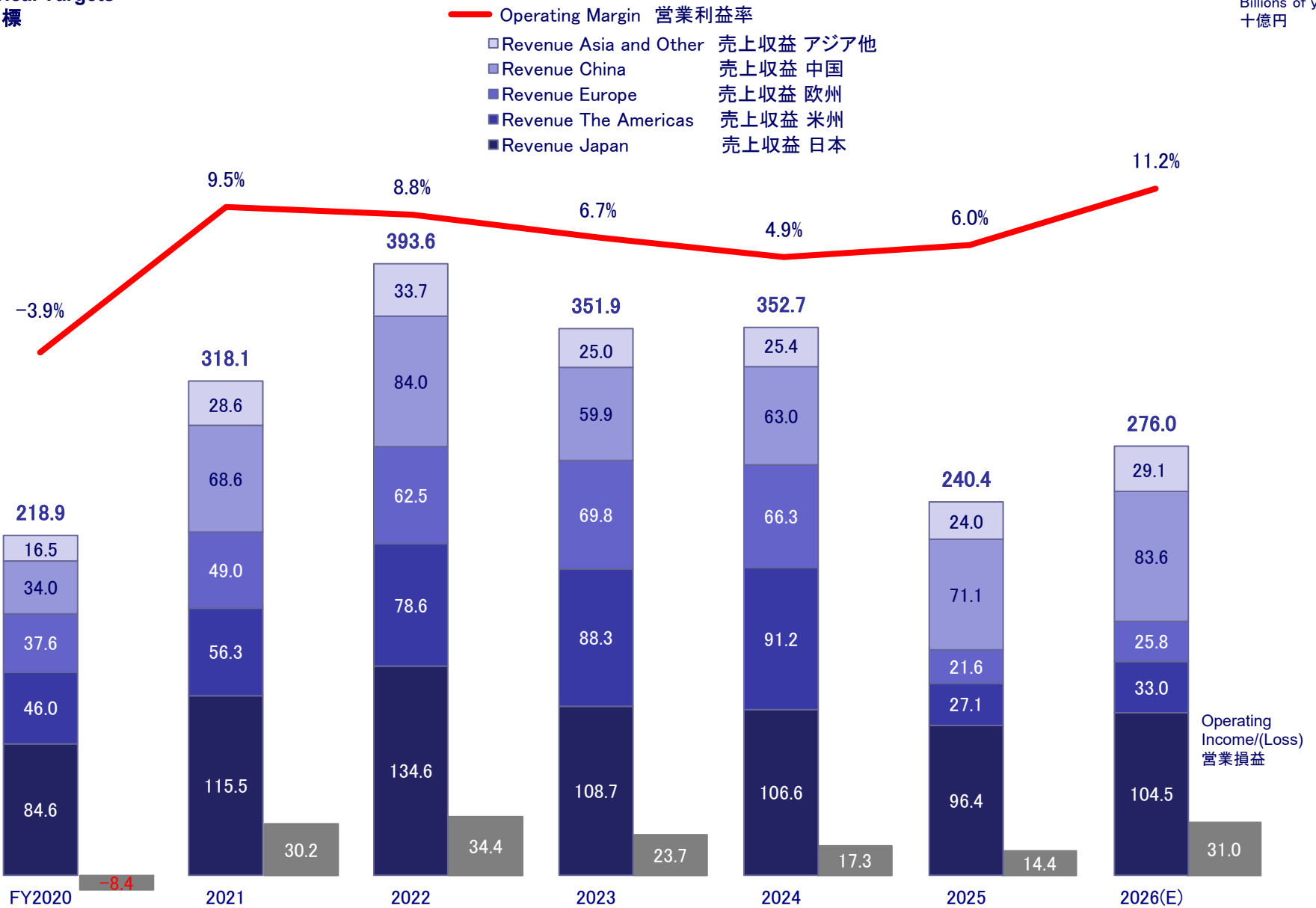

Due to the transfer of the Automotive & Transportation business, the actual results for the fiscal year ending December 2025 and the forecast for the fiscal year ending December 2026 do not include this business.

輸送機器事業の譲渡に伴い、2025年12月期実績及び2026年12月期の業績予想には同事業は含まれておりません。

Capital Expenditure and Number of Employees 設備投資額と従業員数

Billions of yen, Individuals
十億円、人

Capital Expenditures 設備投資額

- Japan 日本
- The Americas 米州
- Europe 欧州
- China 中国
- Asia and Other アジア他

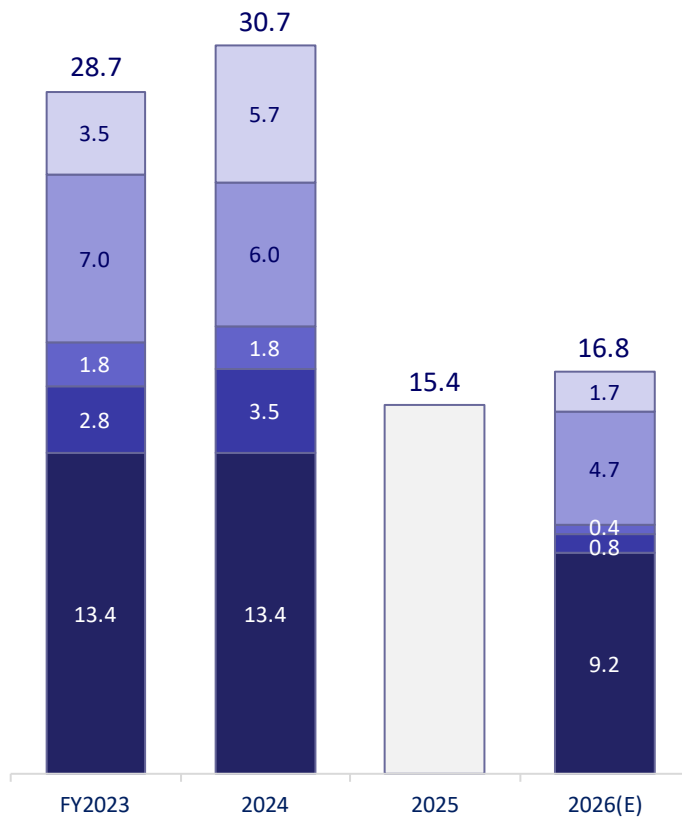

Number of Employees 従業員数

- Japan 日本
- The Americas 米州
- Europe 欧州
- China 中国
- Asia and Other アジア他

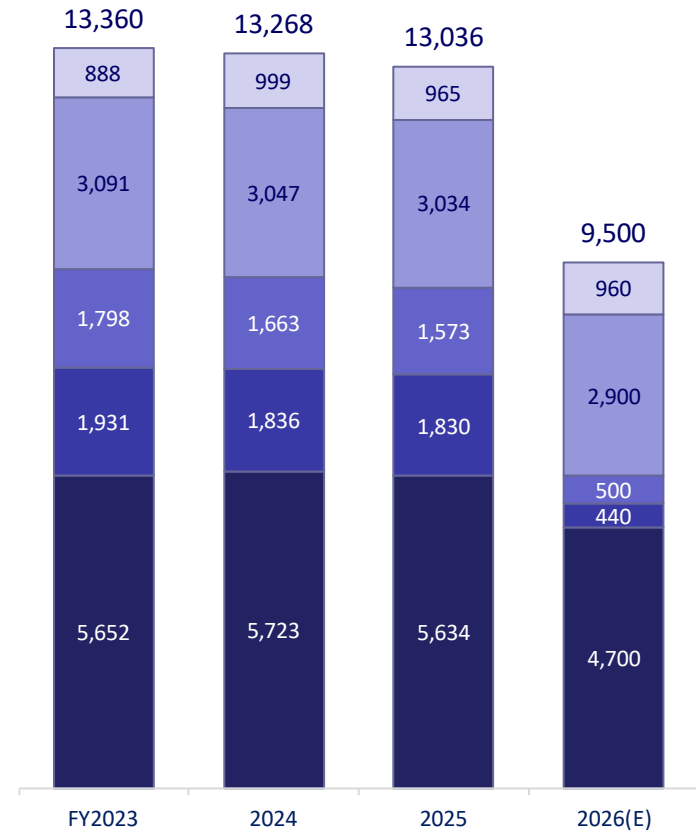

Due to the transfer of the Automotive & Transportation business, the actual results for the fiscal year ending December 2025 and the forecast for the fiscal year ending December 2026 do not include this business, except for the number of employees at the end of 2025. Additionally, the breakdown of capital expenditures by region for 2025 is not provided.

輸送機器事業の譲渡に伴い、2025年の期末従業員数を除き、2025年12月期実績及び2026年12月期の業績予想には同事業は含まれておりません。

また、2025年の設備投資額の地域別内訳は記載しておりません。

Orders Received by Region <Industrial Machinery Business>
地域別受注状況(産業機器事業)

THK CO., LTD. (Japan) *exclude export 輸出を除く
 % Change, Billions of YEN, 前年同期比、十億円

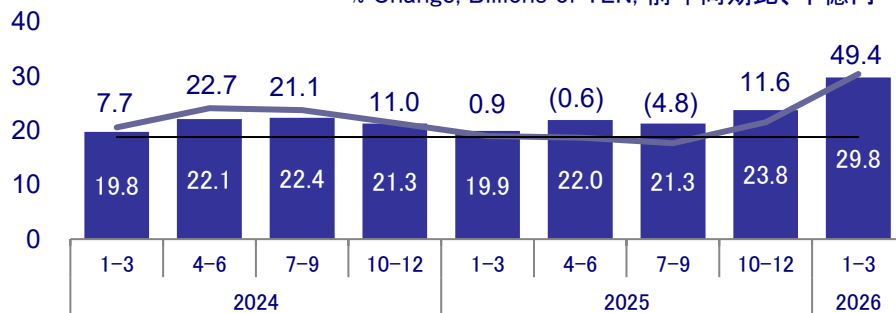

THK Europe B.V.

% Change, Millions of EUR, 前年同期比、百万ユーロ

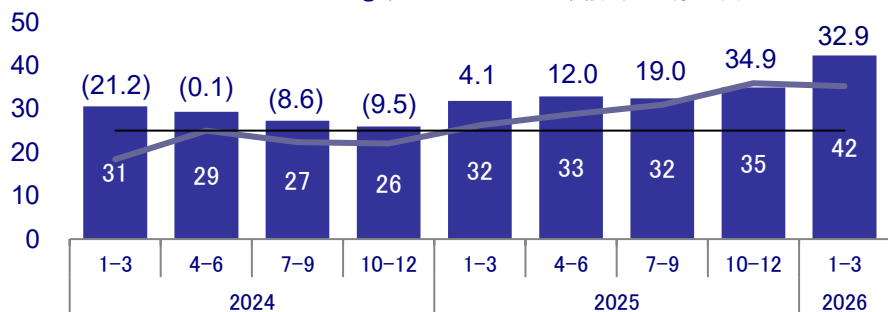

THK America, Inc.

% Change, Millions of USD, 前年同期比、百万ドル

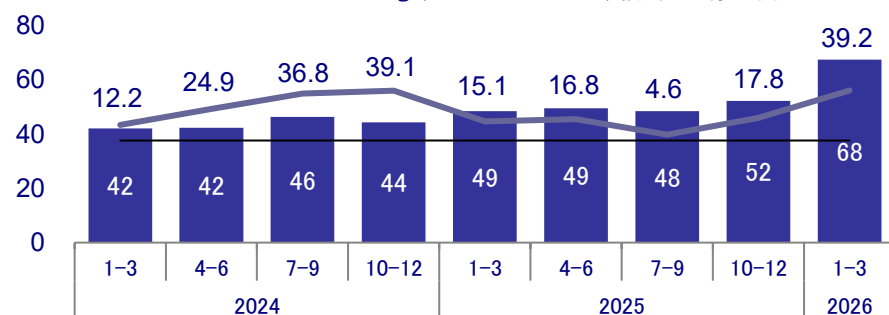

THK (CHINA) CO., LTD. + THK (SHANGHAI) CO., LTD.

% Change, Millions of CNY, 前年同期比、百万元

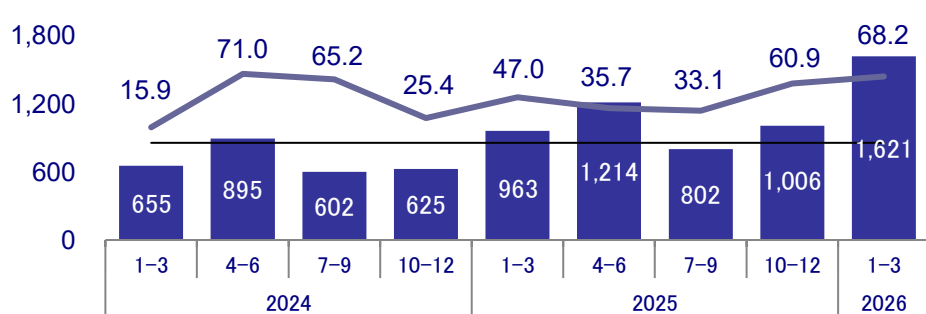

THK TAIWAN CO., LTD.

% Change, Millions of NTD, 前年同期比、百万台湾ドル

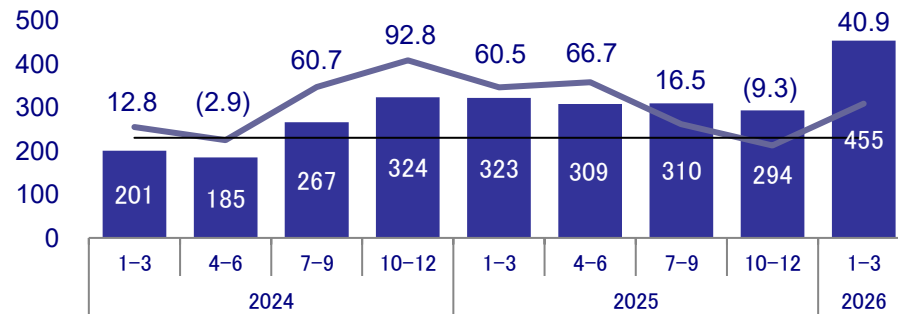

User Sales Breakdown by Industry 業種別売上高構成比

Japan, 日本
THK CO., LTD.

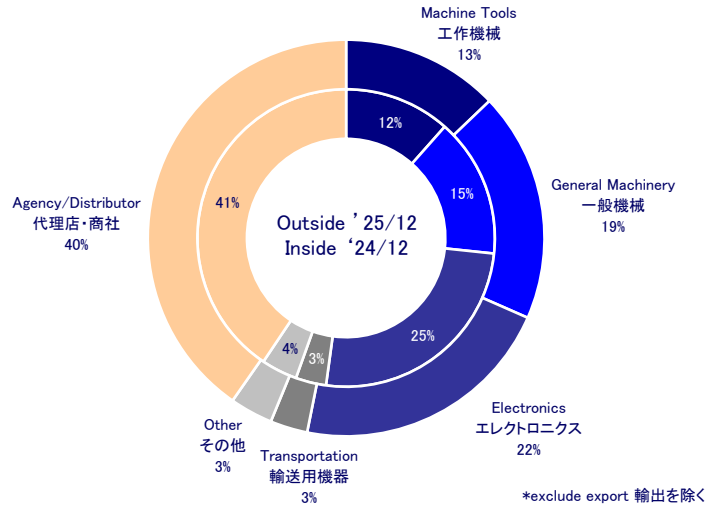

The Americas, 米州
THK America, Inc.

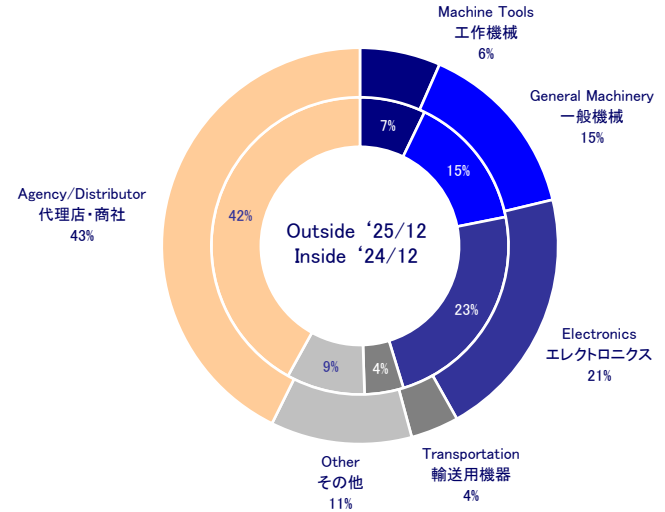

Europe, 欧州
THK Europe B.V.

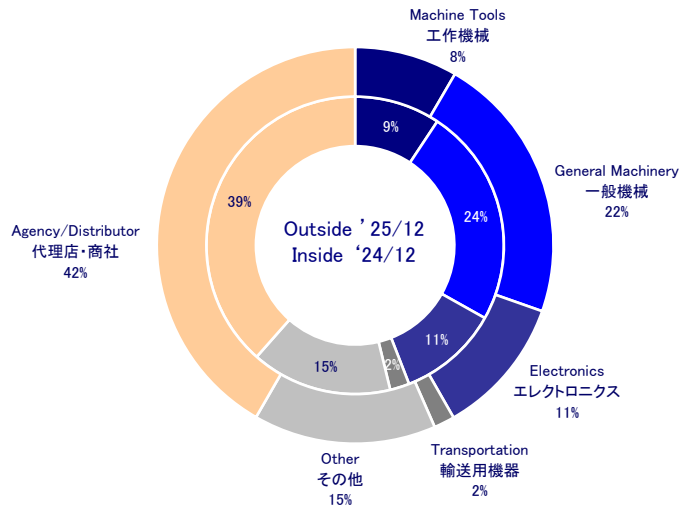

Taiwan, 台湾
THK TAIWAN CO., LTD.

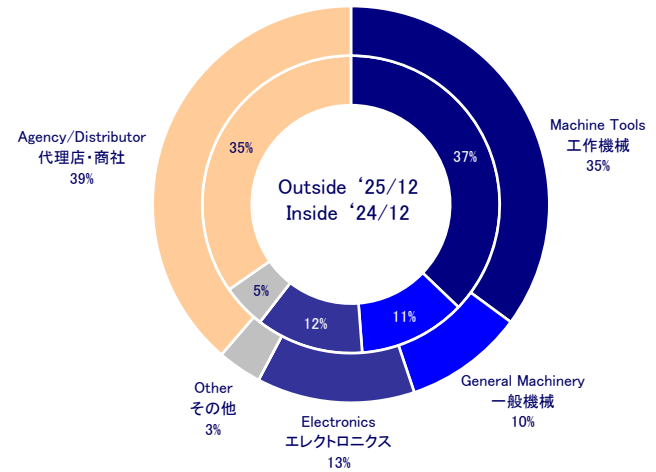

Trend in Japan Orders, Sales, Backlog <Parent Basis>

受注高・売上高・受注残高の推移 -単独-

Millions of yen
百万円

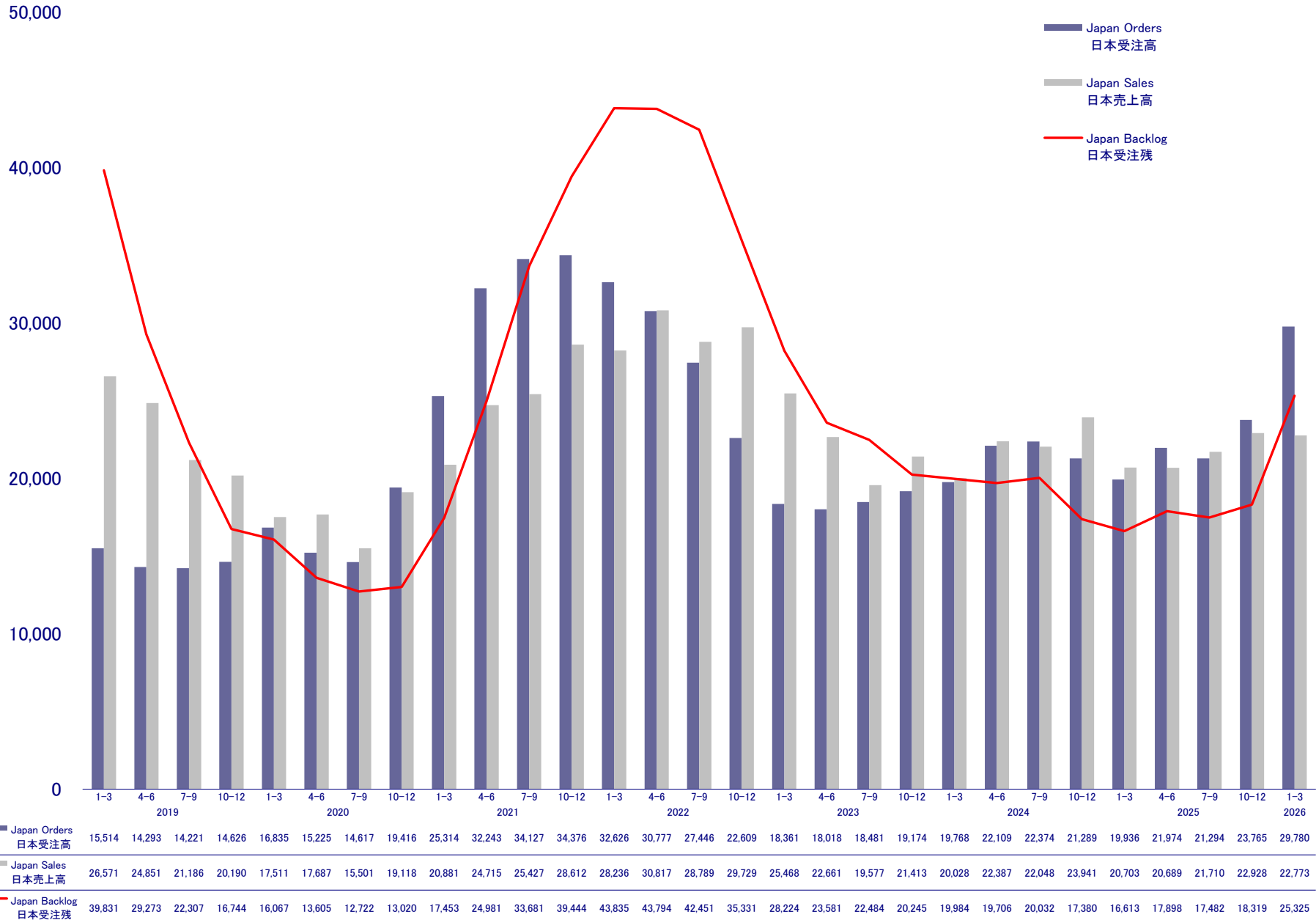

Trend in Orders Classified by Industry <Parent Basis>

業種別受注高の推移 -単独-

Millions of yen
百万円

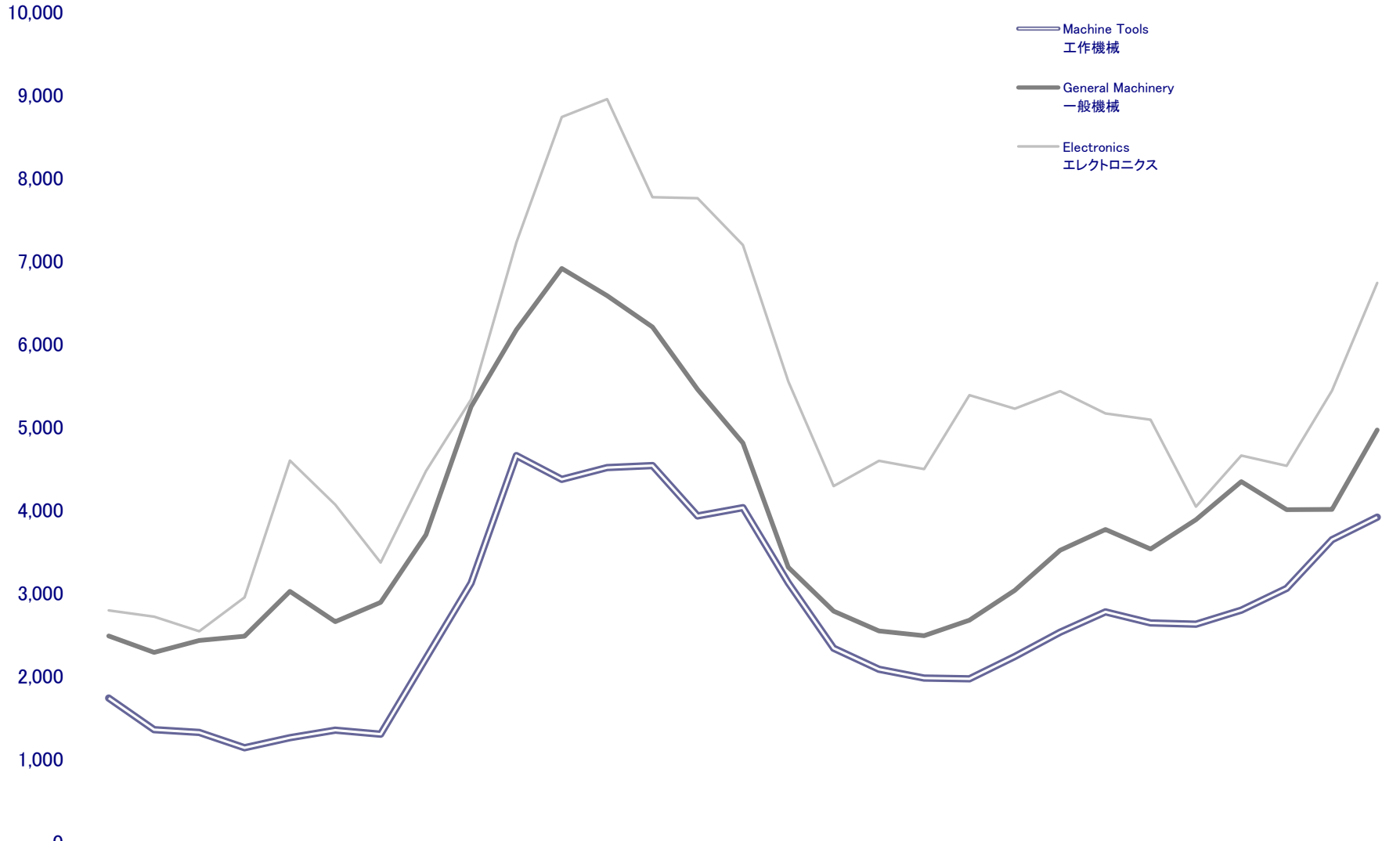

	2019				2020				2021				2022				2023				2024				2025				2026	
	1-3	4-6	7-9	10-12	1-3	4-6	7-9	10-12	1-3	4-6	7-9	10-12	1-3	4-6	7-9	10-12	1-3	4-6	7-9	10-12	1-3	4-6	7-9	10-12	1-3	4-6	7-9	10-12	1-3	4-6
Machine Tools 工作機械	1,737	1,355	1,324	1,138	1,260	1,350	1,301	2,217	3,123	4,659	4,373	4,515	4,539	3,933	4,033	3,125	2,336	2,085	1,977	1,969	2,238	2,532	2,774	2,641	2,627	2,797	3,060	3,646	3,918	
General Machinery 一般機械	2,485	2,287	2,431	2,482	3,024	2,659	2,891	3,706	5,249	6,175	6,915	6,587	6,210	5,458	4,812	3,313	2,783	2,547	2,489	2,675	3,036	3,518	3,769	3,533	3,886	4,347	4,009	4,011	4,968	
Electronics エレクトロニクス	2,793	2,717	2,542	2,950	4,601	4,067	3,369	4,472	5,337	7,230	8,739	8,956	7,773	7,762	7,198	5,553	4,290	4,597	4,497	5,388	5,226	5,436	5,166	5,093	4,043	4,660	4,536	5,441	6,740	

Consolidated Statements of Income
連結損益計算書

Millions of yen, Yen
百万円、円

	'21/12(IFRS)		'22/12(IFRS)		'23/12(IFRS)		'24/12(IFRS)		'25/12(IFRS)		'26/12(IFRS)	
	1H	FY	1H	FY	1H	FY	1H	FY	1H	FY	1H(E)	FY(E)
Revenue 売上収益	151,040	318,188	186,670	393,687	185,593	351,939	179,851	352,759	-	240,444	138,000	276,000
Japan 日本	53,153	115,517	65,917	134,660	57,215	108,740	51,799	106,692	-	96,415		104,500
The Americas 米州	27,408	56,369	35,869	78,684	44,117	88,384	49,472	91,211	-	27,168		33,000
Europe 欧州	25,584	49,014	29,099	62,507	36,668	69,839	36,431	66,390	-	21,611		25,800
China 中国	31,787	68,662	39,168	84,046	34,148	59,919	30,254	63,042	-	71,188		83,600
Asia and other アジア他	13,106	28,624	16,615	33,789	13,443	25,056	11,893	25,423	-	24,059		29,100
Cost of sales 売上原価	115,121	238,434	138,092	288,398	140,300	270,308	139,975	270,975	-	169,949	93,600	188,000
Gross profit 売上総利益	35,919	79,753	48,577	105,288	45,292	81,630	39,876	81,784	-	70,495	44,400	88,000
SG&A 販売費及び一般管理費	25,459	50,988	28,658	58,991	29,915	58,958	32,425	64,639	-	54,341	28,400	56,900
Other income その他の収益	1,198	2,316	1,035	2,015	1,393	2,318	1,433	2,553	-	1,450		
Other expenses その他の費用	740	1,171	335	14,421	394	1,322	509	2,404	-	1,581		
Operating income 営業利益	11,067	30,268	20,905	34,460	16,471	23,707	8,399	17,349	-	14,436	15,400	31,000
Financial income 金融収益	1,192	2,145	2,285	3,335	1,126	2,446	1,919	3,116	-	3,048		
Financial costs 金融費用	1,451	2,430	899	2,199	451	864	238	1,683	-	1,738		
Profit before tax 税引前利益	10,809	29,984	22,291	35,596	17,146	25,289	10,080	18,782	-	15,746	14,500	29,800
Profit attributable to owners of the parent 親会社の所有者に帰属する当期利益	7,521	23,007	14,366	21,198	12,042	18,398	7,213	10,439	-	(69,891)	10,500	22,700
Basic earnings per share 基本的1株あたり当期利益	59.42	181.97	116.85	172.67	98.24	150.08	58.83	85.17	-	(618.66)	93.73	202.64
Foreign-exchange rate 邦貨換算レート*												
US\$ Average rate 平均レート	107.68	109.79	122.98	131.43	134.87	140.52	152.21	151.48	-	149.61		151.71
Euro Average rate 平均レート	129.80	129.85	134.30	138.03	145.79	151.95	164.51	163.81	-	169.00		177.14

Due to the transfer of the Automotive & Transportation business, the results for the fiscal year ending December 2025 and the forecast for the fiscal year ending December 2026 do not include this business, except for the net income attributable to owners of the parent company. Additionally, the actual figures for the first half of the fiscal year, as well as the year-on-year change rates, are not provided.

輸送機器事業の譲渡に伴い、親会社の所有者に帰属する当期損益を除き、2025年12月期実績及び2026年12月期の業績予想には同事業は含まれておりません。また、上半期実績及び対前期比増減率を記載しておりません。

* Foreign currency exchange rates used for translation of accounts of overseas subsidiaries (except 25/12 FY(E))
外貨建財務諸表(連結子会社)の換算レート(26/12 FY(E)を除く)

Consolidated Statements of Income

連結損益計算書

%

	'21/12(IFRS)		'22/12(IFRS)		'23/12(IFRS)		'24/12(IFRS)		'25/12(IFRS)		'26/12(IFRS)	
	1H	FY	1H	FY	1H	FY	1H	FY	1H	FY	1H(E)	FY(E)
Profitability ratio 売上収益利益率												
Gross margin 売上総利益率	23.8	25.1	26.0	26.7	24.4	23.2	22.2	23.2	-	29.3	32.2	31.9
Operating margin 売上収益営業利益率	7.3	9.5	11.2	8.8	8.9	6.7	4.7	4.9	-	6.0	11.2	11.2
Net income margin 売上収益当期利益率	5.0	7.2	7.7	5.4	6.5	5.2	4.0	3.0	-	(29.1)	7.6	8.2
Rate of change 増減率												
Revenue 売上収益	46.6	45.3	23.6	23.7	(0.6)	(10.6)	(3.1)	0.2	-	-	-	14.8
Japan 日本	25.2	36.4	24.0	16.6	(13.2)	(19.2)	(9.5)	(1.9)	-	-	-	8.4
The Americas 米州	36.4	22.3	30.9	39.6	23.0	12.3	12.1	3.2	-	-	-	21.5
Europe 欧州	47.7	30.3	13.7	27.5	26.0	11.7	(0.6)	(4.9)	-	-	-	19.4
China 中国	111.0	101.9	23.2	22.4	(12.8)	(28.7)	(11.4)	5.2	-	-	-	17.4
Asia and other アジア他	61.6	72.5	26.8	18.0	(19.1)	(25.8)	(11.5)	1.5	-	-	-	20.9
Gross profit 売上総利益	56.8	71.8	35.2	32.0	(6.8)	(22.5)	(12.0)	0.2	-	-	-	24.8
Operating income 営業利益	-	-	88.9	13.8	(21.2)	(31.2)	(49.0)	(26.8)	-	-	-	114.7
Profit attributable to owners of the parent 親会社の所有者に帰属する当期利益	-	-	91.0	(7.9)	(16.2)	(13.2)	(40.1)	(43.3)	-	-	-	-

Consolidated Balance Sheets

連結貸借対照表

Millions of yen
百万円

	'20/12(IFRS)		'21/12(IFRS)		'22/12(IFRS)		'23/12(IFRS)		'24/12(IFRS)	
	1H	FY	1H	FY	1H	FY	1H	FY	1H	FY
ASSETS 資産の部										
Total current assets 流動資産	264,090	274,495	310,333	313,922	331,764	352,942	349,702	333,462	342,836	326,804
Cash and cash equivalents 現金及び現金同等物	152,672	158,839	167,302	151,430	142,804	163,835	159,641	156,486	154,794	138,293
Trade and other receivables 営業債権及びその他の債権	54,874	59,505	75,912	86,293	99,420	96,665	91,507	78,621	85,603	81,474
Inventories 棚卸資産	49,846	47,237	57,591	64,378	75,348	77,630	85,867	82,460	88,921	91,660
Assets held for sale 売却目的で保有する資産										
Other その他	6,696	8,913	9,527	11,819	14,191	14,810	12,686	15,893	13,517	15,377
Non-current assets 非流動資産	192,191	185,678	192,400	202,163	218,834	207,361	219,761	222,889	243,940	240,613
Property, plant, and equipment 有形固定資産	152,329	145,922	150,577	158,135	173,585	172,342	182,904	186,556	204,083	203,783
Goodwill and intangible assets のれん及び無形固定資産	19,751	18,779	19,121	18,744	20,056	9,321	10,016	9,492	10,266	9,207
Other その他	20,110	20,976	22,701	25,282	25,193	25,698	26,840	26,839	29,590	27,622
Total assets 資産合計	456,281	460,173	502,733	516,086	550,599	560,304	569,464	556,351	586,776	567,418
LIABILITIES 負債の部										
Total current liabilities 流動負債	68,469	58,500	81,602	78,599	89,627	103,162	95,112	73,643	76,072	80,929
Trade and other payables 営業債務及びその他の債務	35,705	40,293	56,374	49,984	50,481	51,631	46,324	40,881	37,055	34,040
Bonds and borrowings 社債及び借入金	17,256	2,244	2,402	2,545	12,953	22,961	23,123	13,123	13,598	23,371
Liabilities directly associated with assets held for sale 売却目的で保有する資産に直接関連する負債										
Other その他	15,507	15,962	22,825	26,069	26,192	28,569	25,664	19,638	25,418	23,517
Total non-current liabilities 非流動負債	106,700	126,524	124,458	123,197	112,513	119,860	107,793	119,810	107,588	96,693
Bonds and borrowings 社債及び借入金	80,789	100,325	98,879	99,212	88,151	97,917	85,781	95,639	83,217	73,143
Other その他	25,911	26,199	25,579	23,984	24,361	21,943	22,011	24,170	24,371	23,550
Equity 資本の部										
Common stock 資本金	34,606	34,606	34,606	34,606	34,606	34,606	34,606	34,606	34,606	34,606
Capital surplus 資本剰余金	40,413	40,413	40,413	40,413	41,403	40,094	40,102	40,102	40,120	40,120
Retained earnings 利益剰余金	226,554	219,712	226,307	233,607	243,213	245,941	252,191	253,440	258,635	260,638
Treasury stock 自己株式	(14,005)	(14,006)	(14,008)	(11,237)	(17,159)	(17,160)	(17,129)	(17,130)	(17,085)	(21,104)
Other components of equity associated with a disposal group held for sale 売却目的で保有する処分グループに関連するその他の資本の構成要素										
Other その他	(16,320)	(14,235)	148	7,165	37,054	28,406	51,239	46,245	80,593	69,384
Non-controlling interests 非支配持分	9,862	8,657	9,205	9,733	9,340	5,393	5,547	5,633	6,244	6,149
Total equity 資本合計	281,111	275,148	296,672	314,289	348,458	337,281	366,557	362,898	403,115	389,795
Total liabilities and equity 負債資本合計	456,281	460,173	502,733	516,086	550,599	560,304	569,464	556,351	586,776	567,418

Segment Information セグメント情報

Millions of yen
百万円

	'20/12(IFRS)		'21/12(IFRS)		'22/12(IFRS)		'23/12(IFRS)		'24/12(IFRS)		'25/12(IFRS)	
	1H	FY	1H	FY	1H	FY	1H	FY	1H	FY	1H	FY
Japan 日本												
Revenue 売上収益	63,857	126,309	90,381	192,636	108,221	223,459	93,473	173,170	82,567	173,658	-	174,212
External customers 外部顧客への売上収益	45,617	90,378	56,738	123,373	70,661	144,189	61,131	115,357	54,798	112,905	-	110,859
Intersegment セグメント間売上収益	18,239	35,931	33,642	69,263	37,560	79,270	32,342	57,812	27,768	60,752	-	63,352
Operating income セグメント利益(営業利益)	169	(17,400)	8,768	22,262	15,546	17,014	7,301	10,619	4,328	7,845	-	(3,618)
The Americas 米州												
Revenue 売上収益	20,255	46,096	27,619	57,299	37,219	81,109	44,667	89,494	49,829	91,945	-	90,495
External customers 外部顧客への売上収益	20,166	46,019	27,557	57,220	37,074	80,855	44,624	89,225	49,723	91,756	-	90,248
Intersegment セグメント間売上収益	89	77	61	79	144	253	42	268	106	189	-	247
Operating income セグメント利益(営業利益)	(1,215)	(3,239)	(618)	(1,134)	(272)	(2,351)	1,374	2,219	1,046	2,408	-	(36,279)
Europe 欧州												
Revenue 売上収益	18,030	39,508	26,533	50,448	29,381	63,169	37,173	70,958	37,493	68,413	-	68,632
External customers 外部顧客への売上収益	17,953	39,274	26,361	50,247	29,141	62,715	37,019	70,548	37,080	67,599	-	67,516
Intersegment セグメント間売上収益	76	234	171	200	239	453	153	410	412	813	-	1,116
Operating income セグメント利益(営業利益)	(2,022)	(5,983)	(933)	(1,337)	(1,293)	(9,684)	946	1,680	(194)	(407)	-	(26,219)
China 中国												
Revenue 売上収益	15,356	34,560	32,062	69,638	41,007	88,755	36,563	63,954	33,055	66,160	-	78,184
External customers 外部顧客への売上収益	14,651	33,085	30,950	67,072	38,737	83,312	33,884	59,410	29,832	62,525	-	76,034
Intersegment セグメント間売上収益	705	1,474	1,112	2,565	2,270	5,443	2,678	4,544	3,222	3,634	-	2,150
Operating income セグメント利益(営業利益)	1,093	3,730	3,851	9,459	7,019	13,773	5,395	7,486	3,402	7,202	-	1,874
Other その他												
Revenue 売上収益	5,618	12,038	10,896	23,033	12,967	26,880	11,191	21,147	10,560	22,615	-	26,512
External customers 外部顧客への売上収益	4,662	10,240	9,433	20,274	11,054	22,614	8,931	17,397	8,415	17,972	-	21,603
Intersegment セグメント間売上収益	956	1,797	1,463	2,759	1,912	4,265	2,259	3,749	2,145	4,643	-	4,908
Operating income セグメント利益(営業利益)	212	647	1,170	2,278	978	2,861	725	981	523	746	-	111
Adjustments 調整額												
	358	13,746	(1,171)	(1,260)	(1,074)	12,847	727	718	(707)	(446)	-	(912)

The actual results for the fiscal year ending December 2025 include the Automotive & Transportation business. Additionally, the actual figures for the first half of the fiscal year are not provided.
2025年12月期実績には輸送機器事業は含まれております。また、上半期実績は記載しておりません。

Overviews of Major Subsidiaries 主要子会社

	'19/12	'20/12	'21/12	'22/12	'23/12	'24/12	'25/12	'26/12(E)
THK America, Inc. *								Millions of USD 百万ドル
Revenue 売上収益	168	145	199	227	180	178	192	220
y/y 前年比	-	(13.7%)	+37.1%	+13.9%	(20.6%)	(1.1%)	+7.9%	+14.1%
Operating income 営業利益	13	11	14	16	14	13	17	19
y/y 前年比	-	(15.1%)	+30.9%	+14.7%	(16.4%)	(1.1%)	+22.8%	+11.6%
Operating margin 売上収益営業利益率	7.8%	7.7%	7.3%	7.4%	7.8%	7.8%	8.8%	8.6%
Exchange rate 換算レート	¥109.04	¥106.79	¥109.79	¥131.43	¥140.52	¥151.48	¥149.61	¥151.71

	'19/12	'20/12	'21/12	'22/12	'23/12	'24/12	'25/12	'26/12(E)
THK Europe B.V. *								Millions of EUR 百万ユーロ
Revenue 売上収益	178	107	142	167	156	126	125	145
y/y 前年比	-	(39.9%)	+32.7%	+18.1%	(6.6%)	(19.3%)	(1.1%)	+15.9%
Operating income 営業利益	12	(8)	0	4	6	(5)	(13)	4
y/y 前年比	-	-	-	-	+55.7%	-	-	-
Operating margin 売上収益営業利益率	6.8%	(7.9%)	0.2%	2.5%	4.2%	(4.4%)	(11.1%)	2.8%
Exchange rate 換算レート	¥122.08	¥121.79	¥129.85	¥138.03	¥151.95	¥163.81	¥169.00	¥177.14

	'19/12	'20/12	'21/12	'22/12	'23/12	'24/12	'25/12	'26/12(E)
THKリズム連結								
THK RHYTHM (Consolidated)								Millions of YEN 百万円
Revenue 売上収益	41,425	31,640	32,847	38,511	46,106	46,876	48,918	-
y/y 前年比	-	(23.6%)	+3.8%	+17.2%	+19.7%	+1.7%	+4.4%	-
Operating income 営業利益	(546)	(8,301)	(1,591)	(5,275)	809	(65)	938	-
y/y 前年比	-	-	-	-	-	-	-	-
Operating margin 売上収益営業利益率	(1.3%)	(26.2%)	(4.8%)	(13.7%)	1.8%	(0.1%)	1.9%	-

	'19/12	'20/12	'21/12	'22/12	'23/12	'24/12	'25/12	'26/12(E)
THK RHYTHM AUTOMOTIVE (Consolidated)								Millions of YEN 百万円
Revenue 売上収益	55,376	43,127	53,462	73,119	88,304	89,266	84,031	-
y/y 前年比	-	(22.1%)	+24.0%	+36.8%	+20.8%	+1.1%	(5.9%)	-
Operating income 営業利益	(3,905)	(7,883)	(3,214)	(11,330)	749	617	538	-
y/y 前年比	-	-	-	-	-	(17.6%)	(12.9%)	-
Operating margin 売上収益営業利益率	(7.1%)	(18.3%)	(6.0%)	(15.5%)	0.8%	0.7%	0.6%	-

*Net sales of THK America, Inc. and THK Europe B.V. shown represent sales to non-THK Group entities.

THK America, Inc.とTHK Europe B.V.の売上高はグループ会社外向け売上高を表示しております。

Due to the transfer of the Automotive & Transportation business, the earnings forecasts for THK RHYTHM and THK RHYTHM AUTOMOTIVE for the fiscal year ending December 2026 are not disclosed. Additionally, the actual results for the fiscal year ending December 2025 do not include the business liquidation loss.

輸送機器事業の譲渡に伴い、THK RHYTHM 及びTHK RHYTHM AUTOMOTIVEの2026年12月期の業績予想は非開示としております。また、2025年12月期実績には事業整理損失は含まれておりません。

Capital Expenditure, Depreciation, R&D Expenses, and Number of Employees
設備投資額、減価償却費、研究開発費、従業員数

Millions of yen, Employees
 百万円、人

	'21/12		'22/12		'23/12		'24/12		'25/12		'26/12	
	1H	FY	1H	FY	1H	FY	1H	FY	1H	FY	1H(E)	FY(E)
Capital Expenditure 設備投資額												
Consolidated 連結	8,079	21,422	14,393	31,428	12,737	28,757	14,493	30,712	–	15,410	–	16,800
Non-consolidated 単独	3,355	8,614	5,540	11,387	5,335	10,871	5,713	9,776	–	6,596	–	7,900
Depreciation 減価償却費												
Consolidated 連結	7,799	15,824	8,475	17,577	9,101	18,898	10,206	20,808	–	16,479	–	17,900
Non-consolidated 単独	2,757	5,571	2,920	5,964	3,140	6,464	3,351	6,738	–	7,233	–	7,700
R&D expenses 研究開発費												
Consolidated 連結	2,643	5,136	2,848	5,887	2,841	5,690	2,943	6,493	–	5,772	–	6,000
Non-consolidated 単独	2,575	5,066	2,823	5,858	2,787	5,616	2,833	6,277	–	5,676	–	5,700
Number of employees at end of periods 期末従業員数												
Consolidated 連結	13,100	13,073	13,275	13,502	13,528	13,360	13,423	13,268	–	13,036	–	9,500
Non-consolidated 単独	3,986	3,968	4,057	4,058	4,107	4,068	4,106	4,076	–	4,016	–	3,790

Due to the transfer of the Automotive & Transportation business, the actual results for the fiscal year ending December 2025 and the forecast for the fiscal year ending December 2026 do not include this business, except for the number of employees at the end of 2025. Additionally, the actual and forecast figures for the first half of the fiscal year are not provided.

輸送機器事業の譲渡に伴い、2025年の期末従業員数を除き、2025年12月期実績及び2026年12月期の業績予想には同事業は含まれておりません。また、上半期実績・予想を記載しておりません。

Starting from Vol.2 – 2011, issued in May 2011, depreciation and amortization figures represent only those for property, plant and equipment (capital expenditure figures had previously continued to represent only those for property, plant and equipment).

減価償却費は2011年5月発行のVol.2 – 2011より有形固定資産のみの金額を記載(設備投資額は従来より有形固定資産のみの金額を記載)

Non-Consolidated Statement of Income
単独損益計算書

Millions of yen, Yen
 百万円、円

	'21/12		'22/12		'23/12		'24/12		'25/12		'26/12	
	1H	FY	1H	FY	1H	FY	1H	FY	1H	FY	1H(E)	FY(E)
Net sales 売上高	76,722	167,583	95,961	197,624	79,606	144,227	67,606	144,737	67,923	145,070	82,000	164,000
Japan 日本	45,597	99,637	59,054	117,572	48,129	89,121	42,415	88,405	41,393	86,032	47,000	95,700
Direct sales 直接販売	28,459	62,068	37,103	73,240	29,069	53,403	24,508	52,507	24,612	51,367		
Machine tools 工作機械	5,896	13,081	7,866	15,905	6,808	11,892	4,551	10,200	5,136	11,059		
General machinery 一般機械	9,145	19,703	11,224	22,147	7,461	13,496	6,004	13,377	7,877	16,115		
Electronics エレクトロニクス	10,542	23,355	15,332	29,488	11,698	21,775	11,060	22,539	8,721	18,556		
Transportation 輸送用機器	1,329	2,650	1,217	2,684	1,337	2,725	1,424	2,930	1,306	2,618		
Other その他	1,545	3,276	1,462	3,014	1,763	3,513	1,467	3,459	1,570	3,016		
Indirect (agency) sales 代理店	17,137	37,569	21,950	44,332	19,060	35,717	17,907	35,898	16,780	34,664		
Export 輸出	31,125	67,946	36,907	80,051	31,476	55,105	25,190	56,331	26,529	59,037	35,000	68,300
The Americas 米州	5,441	14,908	7,917	18,607	6,390	12,490	5,781	13,792	6,708	13,209		
Europe 欧州	4,040	9,019	5,642	12,415	6,092	11,629	5,060	10,383	3,836	8,696		
Asia and other アジア他	21,642	44,018	23,347	49,029	18,993	30,985	14,349	32,156	15,985	37,132		
Cost of sales 売上原価	57,847	122,783	69,392	140,543	59,054	107,186	50,632	107,988	51,555	108,662	61,400	123,600
Gross profit 売上総利益	18,874	44,799	26,568	57,081	20,552	37,040	16,974	36,748	16,367	36,408	20,600	40,400
SG&A 販売費及び一般管理費	13,824	28,081	15,125	31,358	15,044	29,902	15,429	32,627	16,144	32,172	16,200	33,000
Operating income 営業利益	5,049	16,718	11,443	25,722	5,507	7,138	1,544	4,121	223	4,235	4,400	7,400
Non-operating income 営業外収益	2,312	5,723	9,177	10,047	8,533	9,534	7,955	14,657	34,276	42,670		
Non-operating expense 営業外費用	459	527	250	663	378	766	323	758	1,487	1,802		
Ordinary income 経常利益	6,902	21,914	20,369	35,105	13,662	15,905	9,177	18,020	33,012	45,103	9,700	12,600
Extraordinary gains 特別利益	19	366	245	254	18	468	230	710	32	113		
Extraordinary losses 特別損失	114	330	23	20,316	33	176	69	112	23	70,319		
Net income 当期純利益	5,368	18,348	15,988	6,094	11,176	13,037	8,258	15,495	32,525	(24,701)	8,500	11,100
Earnings per share 1株当たり当期純利益	42.42	145.12	130.03	49.64	91.17	106.35	67.36	126.41	285.49	(218.65)	75.88	99.09

Non-Consolidated Statement of Income

单独損益計算書

%

	'21/12		'22/12		'23/12		'24/12		'25/12		'26/12	
	1H	FY	1H	FY	1H	FY	1H	FY	1H	FY	1H(E)	FY(E)
Profitability ratio 売上高利益率												
Gross margin 売上総利益率	24.6	26.7	27.7	28.9	25.8	25.7	25.1	25.4	24.1	25.1	25.1	24.6
Operating margin 売上高営業利益率	6.6	10.0	11.9	13.0	6.9	4.9	2.3	2.8	0.3	2.9	5.4	4.5
Ordinary income margin 売上高経常利益率	9.0	13.1	21.2	17.8	17.2	11.0	13.6	12.5	48.6	31.1	11.8	7.7
Net income margin 売上高当期純利益率	7.0	10.9	16.7	3.1	14.0	9.0	12.2	10.7	47.9	(17.0)	10.4	6.8
Rate of change 増減率												
Net sales 売上高	48.1	62.9	25.1	17.9	(17.0)	(27.0)	(15.1)	0.4	0.5	0.2	20.7	13.0
Gross profit 売上総利益	50.8	85.0	40.8	27.4	(22.6)	(35.1)	(17.4)	(0.8)	(3.6)	(0.9)	25.9	11.0
Operating income 営業利益	-	-	126.6	53.9	(51.9)	(72.2)	(72.0)	(42.3)	(85.5)	2.8	1867.8	74.7
Ordinary income 経常利益	493.9	934.6	195.1	60.2	(32.9)	(54.7)	(32.8)	13.3	259.7	150.3	(70.6)	(72.1)
Net income 当期純利益	662.5	-	197.8	(66.8)	(30.1)	113.9	(26.1)	18.9	293.9	-	(73.9)	-

Subsidiaries and Affiliate
連結子会社および持分法適用関連会社

As of March 31, 2026
 2026年3月31日現在

Company Name 会社名	Location 所在地	Percentage owned by the company (directly or indirectly) 議決権所有割合 (%)
THK INTECHS CO., LTD. THKインテックス株式会社	Tokyo, Japan 東京都	100.00
TALK SYSTEM CO., LTD. トークシステム株式会社	Tokyo, Japan 東京都	99.00
THK NIIGATA CO., LTD. THK新潟株式会社	Niigata, Japan 新潟県	100.00
THK RHYTHM CO., LTD. THKリズム株式会社	Shizuoka, Japan 静岡県	100.00
NIPPON SLIDE CO., LTD. 日本スライド工業株式会社	Tokyo, Japan 東京都	100.00
TRA Holdings, CO., LTD. TRAホールディングス株式会社	Tokyo, Japan 東京都	100.00
THK KIRYU CO., LTD. THK桐生株式会社	Gunma, Japan 群馬県	100.00
THK America, Inc.	Illinois, USA アメリカ、イリノイ州	100.00
THK Manufacturing of America, Inc.	Ohio, USA アメリカ、オハイオ州	100.00
THK RHYTHM NORTH AMERICA CO., LTD.	Tennessee, USA アメリカ、テネシー州	100.00
THK RHYTHM MEXICANA, S.A. DE C.V.	Guanajuato, Mexico, メキシコ、グアナフアト州	100.00
THK RHYTHM AUTOMOTIVE MICHIGAN CORPORATION	Michigan, USA アメリカ、ミシガン州	100.00
THK RHYTHM AUTOMOTIVE CANADA LIMITED	Ontario, Canada カナダ、オンタリオ州	100.00
THK Europe B.V.	Amsterdam, Netherlands オランダ、アムステルダム市	100.00
THK GmbH	Ratingen, Germany ドイツ、ラティンゲン市	100.00
THK France S.A.S.	Tremblay-en-France, France フランス、トランブレ アン フランス市	100.00
THK Manufacturing of Europe S.A.S.	Ensisheim, France フランス、エンジスハイム市	100.00
THK Manufacturing of Ireland Ltd.	Dublin, Ireland アイルランド、ダブリン市	100.00
THK RHYTHM AUTOMOTIVE GmbH	Duesseldorf, Germany ドイツ、デュッセルドルフ市	100.00
THK RHYTHM AUTOMOTIVE CZECH a.s.	Dacice, Czech Republic チェコ、ダチチェ町	100.00
THK CAPITAL UNLIMITED COMPANYY	Dublin, Ireland アイルランド、ダブリン市	100.00
THK FINANCE UNLIMITED COMPANYY	Dublin, Ireland アイルランド、ダブリン市	100.00

Subsidiaries and Affiliate

連結子会社および持分法適用関連会社

As of March 31, 2026
2026年3月31日現在

Company Name 会社名	Location 所在地	Percentage owned by the company (directly or indirectly) 議決権所有割合 (%)	
THK (CHINA) CO., LTD. THK(中国)投資有限公司	Dalian, China 中国、大連市	100.00	
THK (SHANGHAI) CO., LTD. THK(上海)国際貿易有限公司	Shanghai, China 中国、上海市	100.00	
THK MANUFACTURING OF CHINA (DALIAN) CO., LTD. THK(大連)精密工業有限公司	Dalian, China 中国、大連市	100.00	
THK MANUFACTURING OF CHINA (WUXI) CO., LTD. THK(無錫)精密工業有限公司	Wuxi, China 中国、無錫市	100.00	
THK MANUFACTURING OF CHINA (LIAONING) CO., LTD. THK(遼寧)精密工業有限公司	Dalian, China 中国、大連市	100.00	
THK MANUFACTURING OF CHINA (CHANGZHOU) CO., LTD. THK(常州)精工有限公司	Changzhou, China 中国、常州市	100.00	
THK RHYTHM GUANGZHOU CO., LTD. THKリズム(広州)汽车配件有限公司	Guangzhou, China 中国、広州市	100.00	
THK RHYTHM CHANGZHOU CO., LTD. THKリズム(常州)汽车配件有限公司	Changzhou, China 中国、常州市	100.00	
THK TAIWAN CO., LTD.	Taipei, Taiwan 台湾、台北市	100.00	
THK LM SYSTEM Pte. Ltd.	Kaki Bukit, Singapore シンガポール、カキブキ地区	100.00	
THK LM SYSTEM (THAILAND) CO., LTD.	Samutprakarn, Thailand タイ、サムットプラカーン県	100.00	
THK RHYTHM (THAILAND) CO., LTD.	Rayong, Thailand タイ、ラヨーン県	100.00	
THK MANUFACTURING OF VIETNAM CO., LTD.	Bac Ninh, Vietnam ベトナム、バックニン省	100.00	
THK RHYTHM MALAYSIA Sdn. Bhd.	Penang, Malaysia マレーシア、ペナン州	100.00	
THK India Pvt. Ltd.	Andhra Pradesh, India インド、アンドラプラデーシュ州	100.00	
SAMICK THK CO., LTD. 三益THK株式会社	Daegu, Republic of Korea 韓国、テグ市	33.82	Equity investee 持分法適用関連会社

Main Products and Service
主要製品・サービス

Ball Screw
ボールねじ



Linear Motion Guide
LMガイド

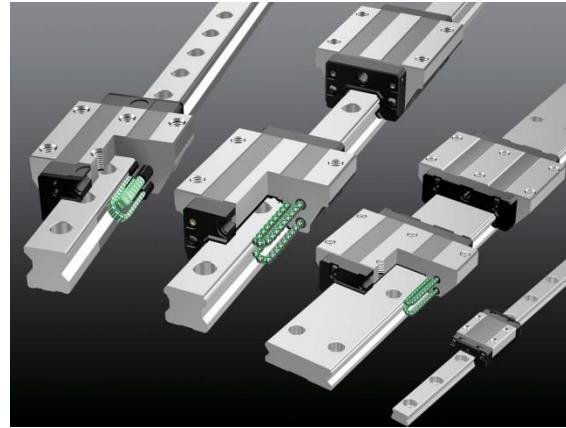

Ball Spline
ボールスプライン

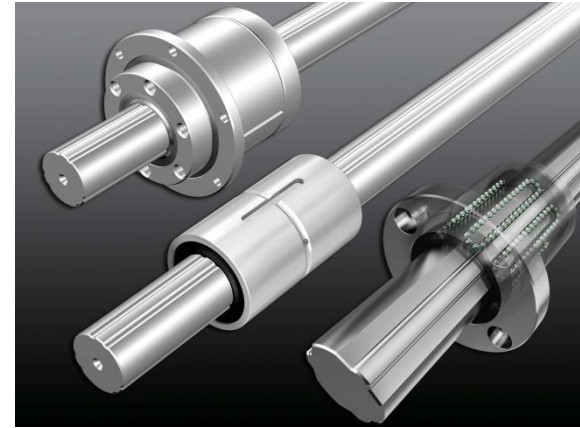

Cross Roller Ring
クロスローラーリング



Electric Actuator
電動アクチュエータ



OMNI edge
オムニエッジ



History 沿革

Billions of yen
十億円

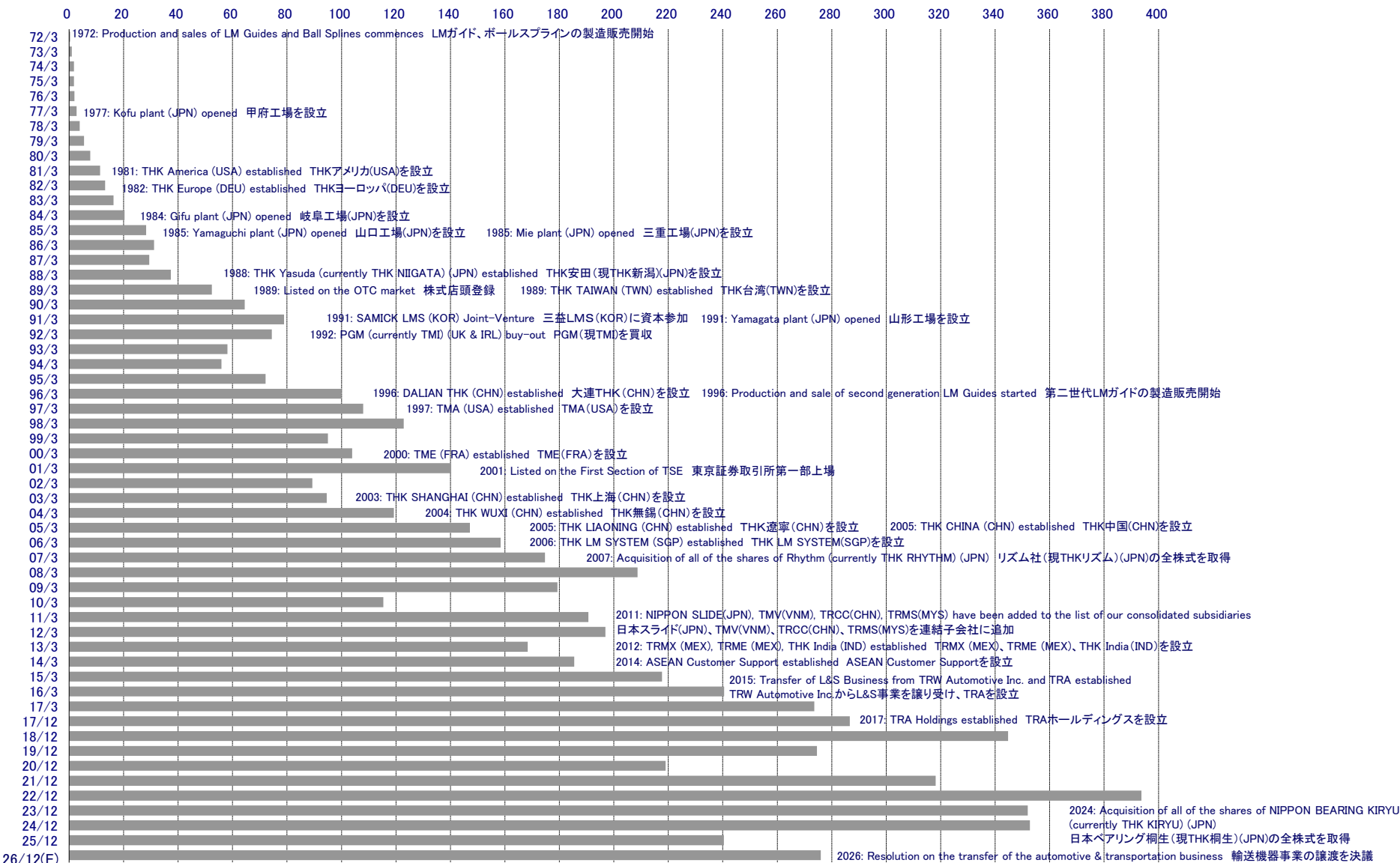

Due to the transfer of the Automotive & Transportation business, the actual results for the fiscal year ending December 2025 and the forecast for the fiscal year ending December 2026 do not include this business.

輸送機器事業の譲渡に伴い、2025年12月期実績及び2026年12月期の業績予想には同事業は含まれておりません。

Figures for 72/3-90/3: Non-consolidated Net Sales 91/3-24/12(E): Consolidated Net Sales

72/3-90/3については単独売上高 91/3-24/12(E)については連結売上高

The financial results for the fiscal year ending in December 2017 is based on an irregular accounting period: 9 months for Japanese companies and 12 months for overseas companies.

2017年12月期は国内9ヵ月、海外12ヵ月の変則決算

Plants in Japan

日本の生産拠点



THK CO., LTD., Yamagata Plant
THK株式会社 山形工場

Major Products 主要生産品目
LM Guide LMガイド
Ball Screw ボールねじ
Electric Actuator 電動アクチュエータ



THK CO., LTD., Kofu Plant
THK株式会社 甲府工場

Major Products 主要生産品目
Ball Screw ボールねじ



THK CO., LTD., Gifu Plant
THK株式会社 岐阜工場

Major Products 主要生産品目
LM Guide LMガイド



THK CO., LTD., Yamaguchi Plant
THK株式会社 山口工場

Major Products 主要生産品目
LM Guide LMガイド



THK CO., LTD., Mie Plant
THK株式会社 三重工場

Major Products 主要生産品目
Cross Roller Ring クロスローラーリング

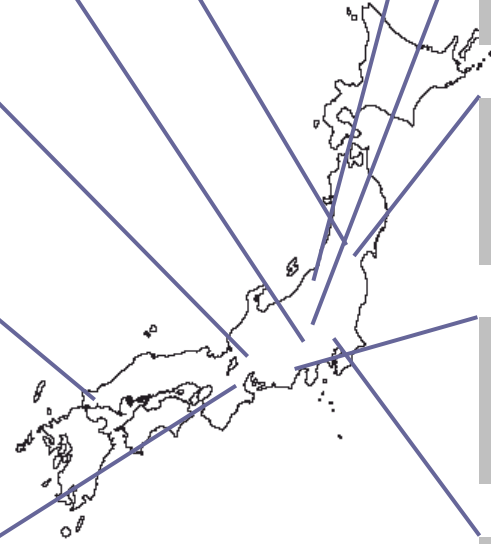

THK NIIGATA CO., LTD.
THK新潟株式会社

Major Products 主要生産品目
Ball Spline ボールスプライン



THK KIRYU CO., LTD.
THK桐生株式会社

Major Products 主要生産品目
LM Guide LMガイド



THK INTECHS CO., LTD., Sendai Plant
THKインテックス株式会社 仙台工場

Major Products 主要生産品目
Machine Tool 工作機械
Machinery and Equipment 機械装置



THK INTECHS CO., LTD., Mishima Plant
THKインテックス株式会社 三島工場

Major Products 主要生産品目
XY Stage XYステージ



NIPPON SLIDE CO., LTD.
日本スライド工業株式会社

Major Products 主要生産品目
Slide Rail スライドレール



Plants in Asia

アジアの生産拠点



THK MANUFACTURING OF CHINA (DALIAN) CO., LTD.
THK(大連)精密工業有限公司

Major Products 主要生産品目
Ball Screw ボールねじ



THK MANUFACTURING OF CHINA (LIAONING) CO., LTD.
THK(遼寧)精密工業有限公司

Major Products 主要生産品目
LM Guide LMガイド
Cross Roller Ring クロスローラーリング



THK MANUFACTURING OF CHINA (WUXI) CO., LTD.
THK(無錫)精密工業有限公司

Major Products 主要生産品目
LM Guide LMガイド



THK MANUFACTURING OF CHINA (CHANGZHOU) CO., LTD.
THK(常州)精工有限公司

Major Products 主要生産品目
LM-related Parts 直動関連部品
Unit Products ユニット製品



THK MANUFACTURING OF VIETNAM CO., LTD.

Major Products 主要生産品目
Slide Rail スライドレール



THK India Pvt. Ltd.

Major Products 主要生産品目
LM Guide LMガイド



SAMICK THK CO., LTD. Headquarters and Daegu Plant
三益THK株式会社 本社工場

Major Products 主要生産品目
LM Guide LMガイド



SAMICK THK CO., LTD., Pyeongtaek Plant
三益THK株式会社 平澤工場

Major Products 主要生産品目
Electric Actuator 電動アクチュエータ
Transfer Robot 移送ロボット
Machinery and Equipment 機械装置



SAMICK THK CO., LTD., Technopolis Plant
三益THK株式会社 テクノポリス工場

Major Products 主要生産品目
LM Guide LMガイド



SAMICK THK CO., LTD., Dasan Plant
三益THK株式会社 茶山工場

Major Products 主要生産品目
LM Guide LMガイド



Plants in the Americas and Europe

欧米の生産拠点



THK Manufacturing of America, Inc.
Major Products 主要生産品目
LM Guide LMガイド
Electric Actuator 電動アクチュエータ



THK Manufacturing of Ireland Ltd.
Major Products 主要生産品目
Ball Screws ボールねじ



THK Manufacturing of Europe S.A.S.
Major Products 主要生産品目
LM Guide LMガイド
Ball Screws ボールねじ



Common Stock Information 株式情報

Stock Price Indices 株価指標

	'21/12	'22/12	'23/12	'24/12	'25/12
Stock Price (High) (Yen) 株価(最高) (円)	4,140	3,070	3,295	3,778	4,464
Stock Price (Low) (Yen) 株価(最低) (円)	2,301	2,195	2,454	2,120	2,971
Number of shares issued (Shares) 発行済株式数(株)	129,856,903	129,856,903	129,856,903	129,856,903	119,099,803
End of period aggregate market value (Billions of yen) 期末時価総額(十億円)	360	326	358	477	477
EPS (Yen) 一株当たり当期利益(円)	181.97	172.67	150.08	85.17	(618.66)
Diluted EPS (Yen) 潜在株式調整後EPS(円)	-	-	-	-	-
BPS (Yen) 一株当たり純資産(円)	2,442.90	2,707.51	2,914.23	3,157.34	2,332.92
DPS (Yen) 一株当たり配当額(円)	60.00	87.00	46.00	146.50	246.00
PER (Times) 株価収益率(倍)	15.24	14.57	18.42	43.21	-
PBR (Times) 株価純資産倍率(倍)	1.1	0.9	0.9	1.2	1.7
Payout Ratio (%) (Consolidated Basis) 配当性向(連結ベース)	33.0	50.4	30.7	172.0	-

Stock Price Chart 株価チャート



Common Stock Information

株式情報

Shareholders by Type
所有者別情報

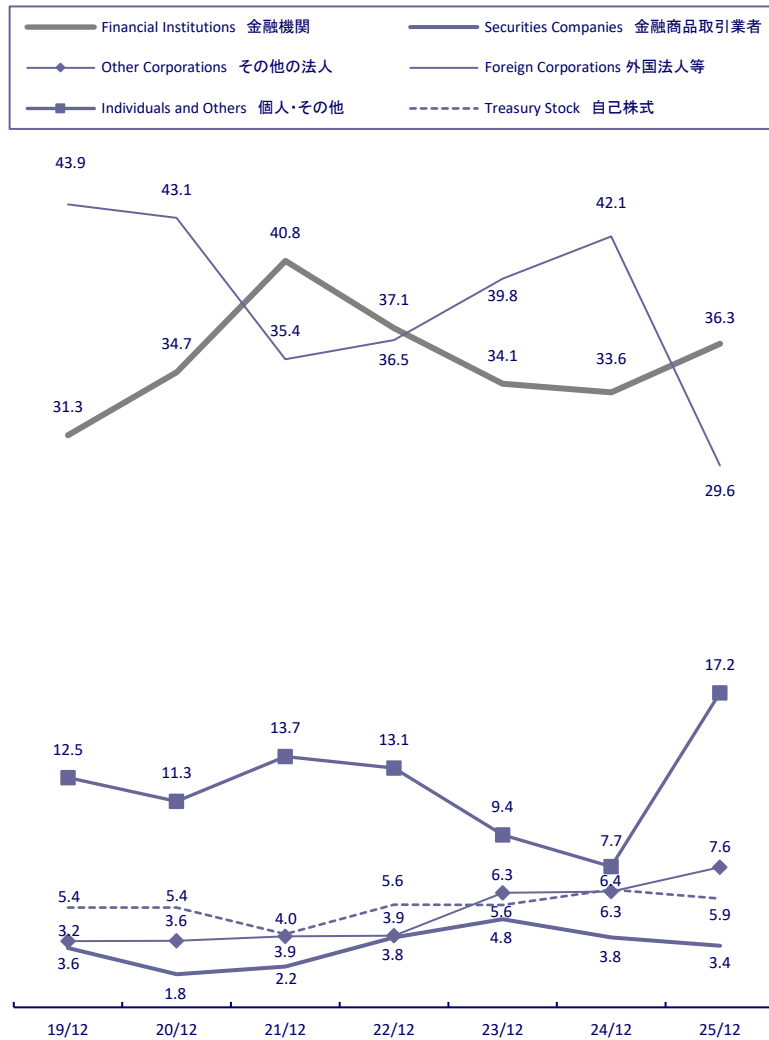

Major Shareholders
大株主

As of December 31, 2025
2025年12月31日現在

持株比率
Percentage of shares (%)

The Master Trust Bank of Japan, Ltd. (Trust Account)	日本マスタートラスト信託銀行株式会社(信託口)	15.16
Custody Bank of Japan, Ltd. (Trust Account)	株式会社日本カस्टディ銀行(信託口)	12.31
THK CO., LTD.	THK株式会社	5.94
TERAMACHI CORPORATION	TERAMACHI株式会社	5.04
STATE STREET BANK AND TRUST CAMPANY 505001	STATE STREET BANK AND TRUST CAMPANY 505001	3.86
BBH (LUX) FOR FIDELITY FUNDS-GLOBAL TECHNOLOGY POOL	BBH (LUX) FOR FIDELITY FUNDS-GLOBAL TECHNOLOGY POOL	2.15
OASIS JAPAN STRATEGIC FUND Y LTD.	OASIS JAPAN STRATEGIC FUND Y LTD.	1.67
Custody Bank of Japan, Ltd. (Trust Account 4)	株式会社日本カस्टディ銀行(信託口4)	1.43
Mizuho Bank, Ltd.	株式会社みずほ銀行	1.34
OASIS JAPAN STRATEGIC FUND LTD.	OASIS JAPAN STRATEGIC FUND LTD.	1.31

THK CO., LTD.

THK株式会社

Head Office: 2-12-10
Shibaura, Minato-ku,
Tokyo 108-8506, Japan

本社: 〒108-8506
東京都港区芝浦2-12-10

Established: April 1971

設立: 1971年4月

Common Stock
Authorized: 465,877,700 (As of December 31, 2025)
Issued: 119,099,803 (As of December 31, 2025)

普通株式
会社が発行する株式の総数: 465,877,700 (2025年12月31日現在)
発行済株式総数: 119,099,803 (2025年12月31日現在)

Number of Shareholders: 38,944 (As of December 31, 2025)

株主数: 38,944 (2025年12月31日現在)

Transfer Agent: Mitsubishi UFJ Trust and Banking Co., Ltd.

名義書換代理人: 三菱UFJ信託銀行株式会社

Stock Exchange Listings: Tokyo Stock Exchange (Prime Market)

上場取引所: 東京証券取引所 (プライム市場)

Ticker Code on the TSE: 6481

証券コード: 6481

Investor Relations: IR (Investor Relations) Section,
The President's Office
E-mail: thk-ir@thk.co.jp
URL: www.thk.com

お問合せ先: 社長室 IR課
E-mail: thk-ir@thk.co.jp
URL: www.thk.com

In this presentation material contains forward-looking statements that reflect the Company's business plans, performance projections, and management strategy. Such statements are based on information currently available to the Company. However, changes in the operating environment may cause actual results and achievements to differ from those anticipated in this Corporate Presentation material. Also, please let you know that this briefing contains reference information that are not exactly accounts indication matters.

本資料に含まれている事業計画、業績予想、経営戦略など将来の見通しに関する事項は、本資料制作時点において入手可能な情報に基づき、THK株式会社の経営者が判断したものです。したがって、環境の変化により、業績や戦略の進捗状況が異なることがあり得ることをご承知ください。また、当資料には決算開示事項以外の参考情報が含まれますこともご承知ください。

E-mail: thk-ir@thk.co.jp

Web Site: www.thk.com