

X Stages 60 x 60, 90 x 90, 125 x 125

0.75 A/phase 0.75 A/phase motor

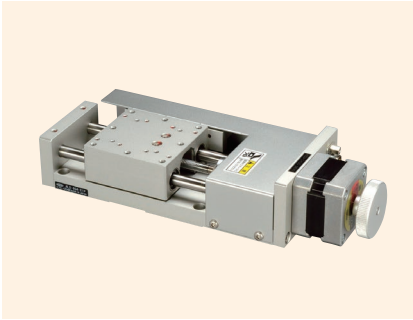

↑ TALS-604-E1P

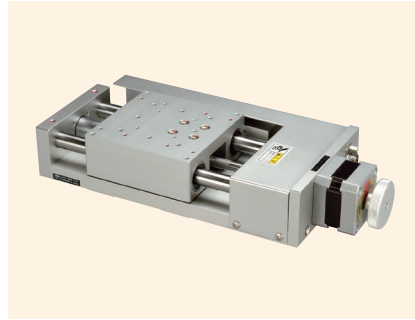

↑ TALS-906-E1P

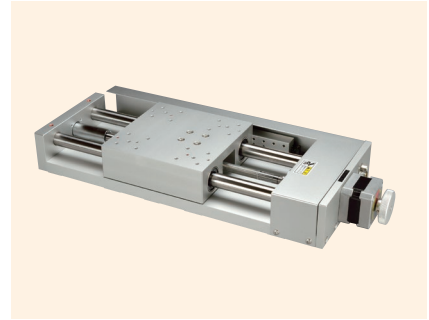

↑ TALS-115-E1P

Features

- A motorized stage that adopts ball bushings for medium precision.
- Can be used for applications for automatic positioning of various sensors and workpieces.
- Pre-home sensor and limit sensor positions can be adjusted.

Model number	TALS-604-E1P	TALS-906-E1P	TALS-115-E1P
Model name	X Stage		
Travel direction	X-axis single direction		
Travel amount	±20 mm	±30 mm	±75 mm
Stage surface	60 mm x 60 mm	90 mm x 90 mm	125 mm x 125 mm
Motor used	PK543NBW equivalent (5-wire type pentagonal wiring, 0.75 A/phase)		
Resolution	0.002 mm		
Feed screw specification	Ball screw		
Feed screw lead	1 mm		
Travel guide	Ball bushing		
Travel accuracy	Straightness (horizontal/vertical): 0.015 mm		
Positioning accuracy	0.03 mm	0.04 mm	
Repeatability	±0.003 mm	±0.003 mm	
Lost motion	0.01 mm		
Load capacity	49 N (5 kgf)	98 N (10 kgf)	147 N (15 kgf)
Mass	1.2 kg	2.5 kg	5.5 kg
Maximum speed (at 8,000 pps)	16 mm/s		
Main materials/surface treatment	Aluminum alloy/white satin anodized finish		
Home position sensor	Normally open contact (make contact, A contact) operation, photo sensor		
Pre-home sensor	Normally closed contact point (break contact, B contact) operation, photo sensor		
Limit sensor	Normally closed contact point (break contact, B contact) operation, photo sensor		
Applicable cables	TACB-STD-D3, TARC-STD-D3		

◆ Sensor operating logic and timing chart

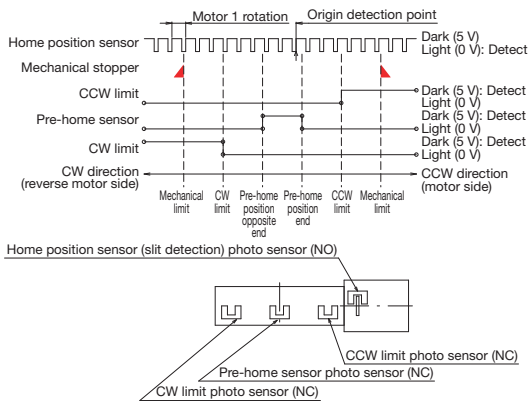

◆ Connection method: Connection cable and driver

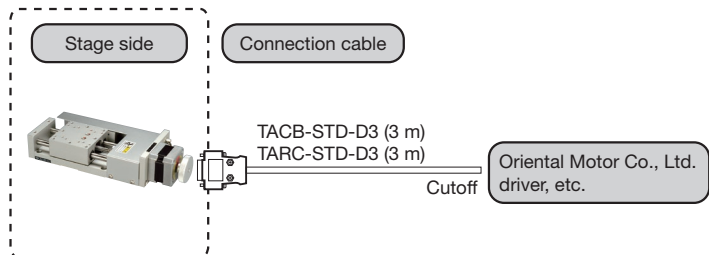



Ball Bushing Stages ◀ Motorized Stages ◀

Product Appearance

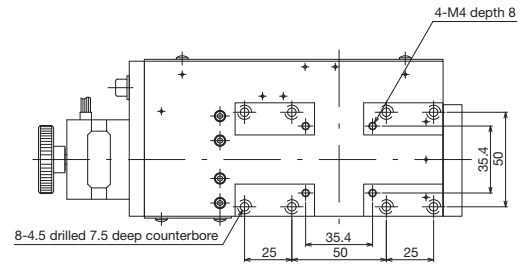
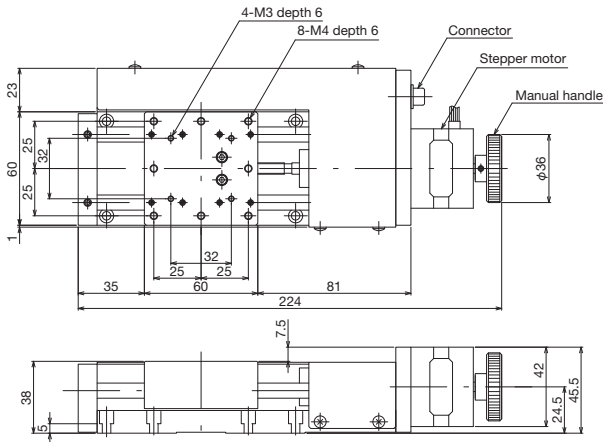

↑ TALS-604-E1P

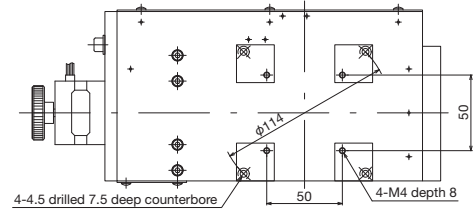
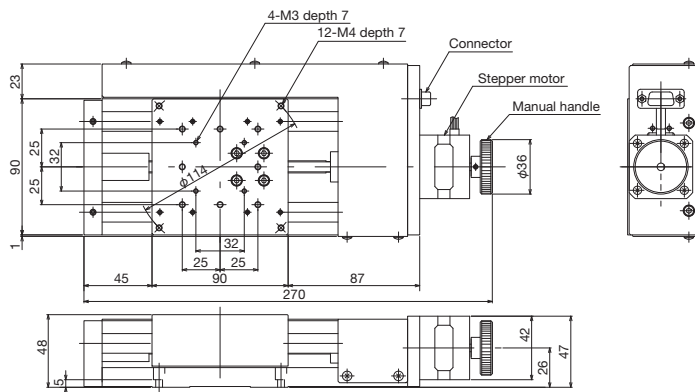

↑ TALS-906-E1P

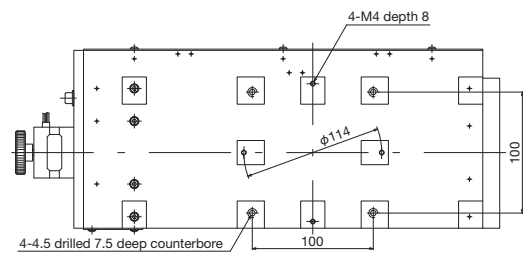
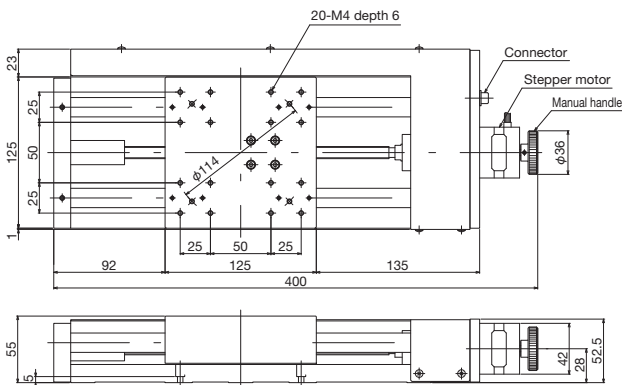

↑ TALS-115-E1P

Motorized Stages	Automated Products for Microscopes	High-Grade Stages	30 mm x 30 mm (ø30 mm) Connector Stages	Class Roller Stages	Ball Bushing Stages	High-Precision/High-Rigidity Stages	Z-Lift Stages	Tilt Stages	Connection Cases	Actuators
------------------	------------------------------------	-------------------	---	---------------------	---------------------	-------------------------------------	---------------	-------------	------------------	-----------